

- ★ 100% EAS Guaranteed
- ★ Green Device Available
- ★ Super Low Gate Charge
- ★ Excellent CdV/dt effect decline
- ★ Advanced high cell density Trench technology

Product Summary



BVDSS	RDSON	ID
30V	5.5mΩ	40A

Description

The FKBB3006 is the high cell density trenched N-ch MOSFETs, which provide excellent RDSON and gate charge for most of the synchronous buck converter applications.

The FKBB3006 meet the RoHS and Green Product requirement, 100% EAS guaranteed with full function reliability approved.

PRPAK3X3 Pin Configuration

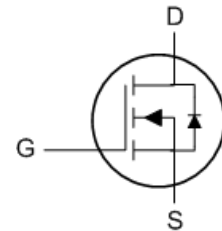
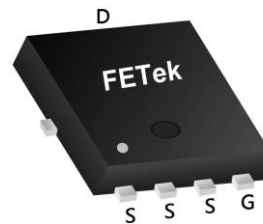

Absolute Maximum Ratings

Symbol	Parameter	Rating	Units
V_{DS}	Drain-Source Voltage	30	V
V_{GS}	Gate-Source Voltage	± 20	V
$I_D@T_C=25^\circ C$	Continuous Drain Current, $V_{GS} @ 10V^1$	40	A
$I_D@T_C=100^\circ C$	Continuous Drain Current, $V_{GS} @ 10V^1$	20	A
$I_D@T_A=25^\circ C$	Continuous Drain Current, $V_{GS} @ 10V^1$	15	A
$I_D@T_A=70^\circ C$	Continuous Drain Current, $V_{GS} @ 10V^1$	12	A
I_{DM}	Pulsed Drain Current ²	140	A
EAS	Single Pulse Avalanche Energy ³	115.2	mJ
I_{AS}	Avalanche Current	48	A
$P_D@T_C=25^\circ C$	Total Power Dissipation ⁴	59	W
$P_D@T_A=25^\circ C$	Total Power Dissipation ⁴	2	W
T_{STG}	Storage Temperature Range	-55 to 150	$^\circ C$
T_J	Operating Junction Temperature Range	-55 to 150	$^\circ C$

Thermal Data

Symbol	Parameter	Typ.	Max.	Unit
$R_{\theta JA}$	Thermal Resistance Junction-Ambient ¹	---	62	$^\circ C/W$
$R_{\theta JC}$	Thermal Resistance Junction-Case ¹	---	2.1	$^\circ C/W$

**Electrical Characteristics (T_J=25 °C, unless otherwise noted)**

Symbol	Parameter	Conditions	Min.	Typ.	Max.	Unit
BV _{DSS}	Drain-Source Breakdown Voltage	V _{GS} =0V, I _D =250uA	30	---	---	V
R _{DS(ON)}	Static Drain-Source On-Resistance ²	V _{GS} =10V, I _D =20A	---	4.8	5.5	mΩ
		V _{GS} =4.5V, I _D =10A	---	6.5	9	
V _{GS(th)}	Gate Threshold Voltage	V _{GS} =V _{DS} , I _D =250uA	1.2	---	2.5	V
I _{DSS}	Drain-Source Leakage Current	V _{DS} =24V, V _{GS} =0V, T _J =25°C	---	---	1	uA
		V _{DS} =24V, V _{GS} =0V, T _J =55°C	---	---	5	
I _{GSS}	Gate-Source Leakage Current	V _{GS} =±20V, V _{DS} =0V	---	---	±100	nA
g _{fs}	Forward Transconductance	V _{DS} =5V, I _D =30A	---	43	---	S
R _g	Gate Resistance	V _{DS} =0V, V _{GS} =0V, f=1MHz	---	1.7	---	Ω
Q _g	Total Gate Charge (4.5V)	V _{DS} =15V, V _{GS} =4.5V, I _D =15A	---	20	---	nC
Q _{gs}	Gate-Source Charge		---	7.6	---	
Q _{gd}	Gate-Drain Charge		---	7.2	---	
T _{d(on)}	Turn-On Delay Time	V _{DD} =15V, V _{GS} =10V, R _G =3.3Ω I _D =15A	---	7.8	---	ns
T _r	Rise Time		---	15	---	
T _{d(off)}	Turn-Off Delay Time		---	37.3	---	
T _f	Fall Time		---	10.6	---	
C _{iss}	Input Capacitance	V _{DS} =15V, V _{GS} =0V, f=1MHz	---	2295	---	pF
C _{oss}	Output Capacitance		---	267	---	
C _{rss}	Reverse Transfer Capacitance		---	210	---	

Diode Characteristics

Symbol	Parameter	Conditions	Min.	Typ.	Max.	Unit
I _S	Continuous Source Current ^{1,6}	V _G =V _D =0V, Force Current	---	---	40	A
I _{SM}	Pulsed Source Current ^{2,6}		---	---	140	A
V _{SD}	Diode Forward Voltage ²	V _{GS} =0V, I _S =1A, T _J =25°C	---	---	1	V
t _{rr}	Reverse Recovery Time	I _F =20A, di/dt=100A/μs,	---	14	---	nS
Q _{rr}	Reverse Recovery Charge	T _J =25°C	---	5	---	nC

Note :

- The data tested by surface mounted on a 1 inch² FR-4 board with 20Z copper.
- The data tested by pulsed, pulse width ≤ 300us, duty cycle ≤ 2%
- The EAS data shows Max. rating. The test condition is V_{DD}=25V, V_{GS}=10V, L=0.1mH, I_{AS}=48A
- The power dissipation is limited by 150°C junction temperature
- The data is theoretically the same as I_D and I_{DM}, in real applications, should be limited by total power dissipation.

Typical Characteristics

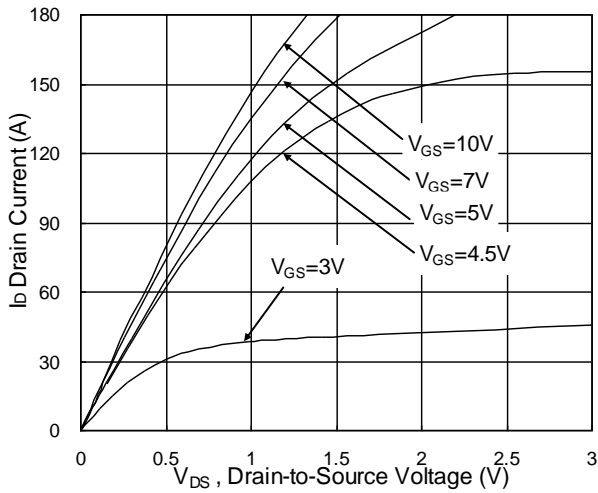

Fig.1 Typical Output Characteristics

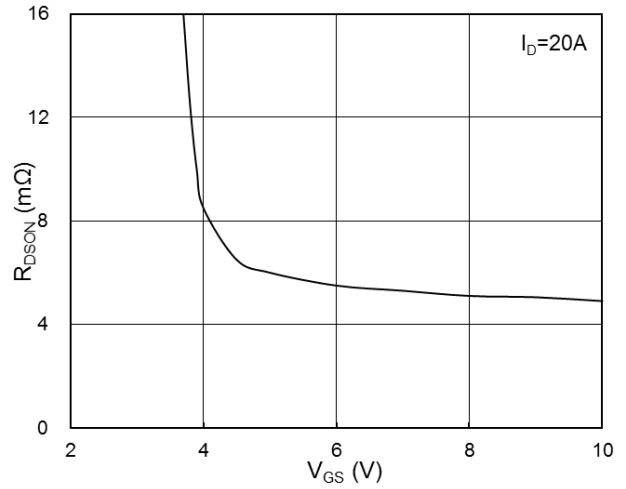

Fig.2 On-Resistance vs. G-S Voltage

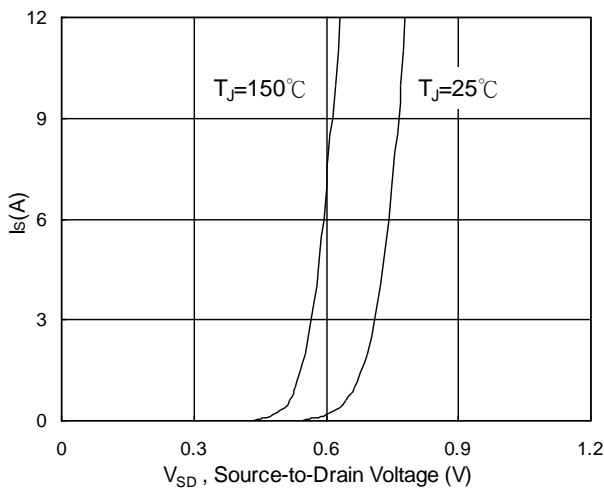

Fig.3 Forward Characteristics of Reverse

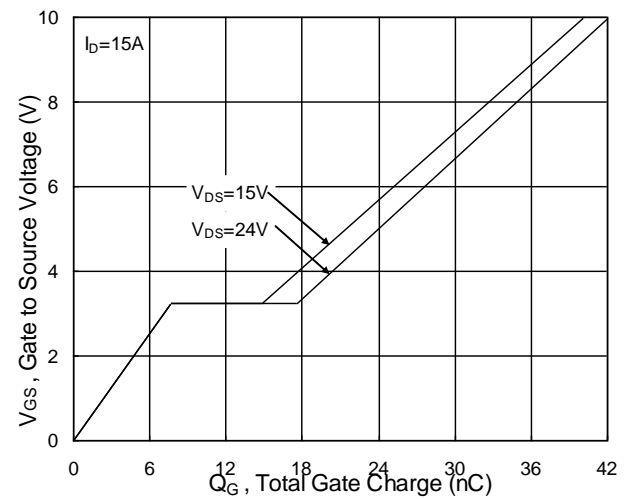

Fig.4 Gate-Charge Characteristics

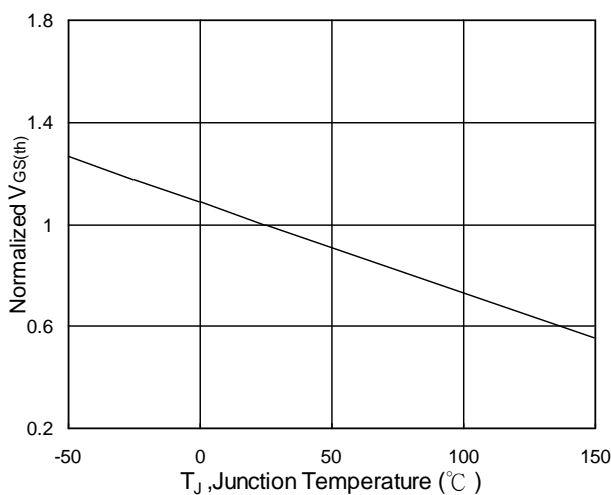

Fig.5 Normalized $V_{GS(th)}$ vs. T_J

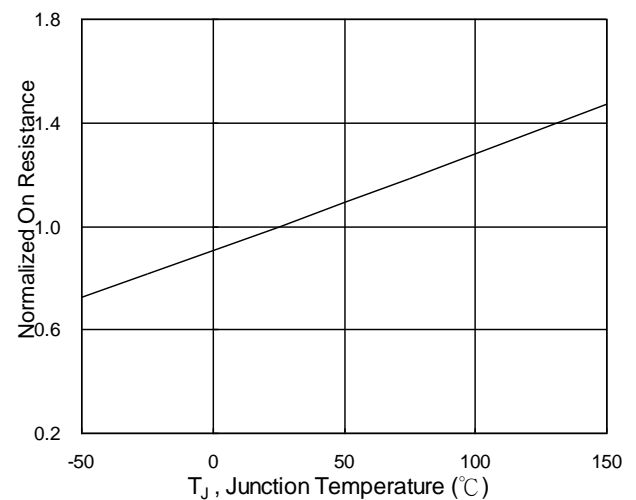

Fig.6 Normalized $R_{DS(on)}$ vs. T_J

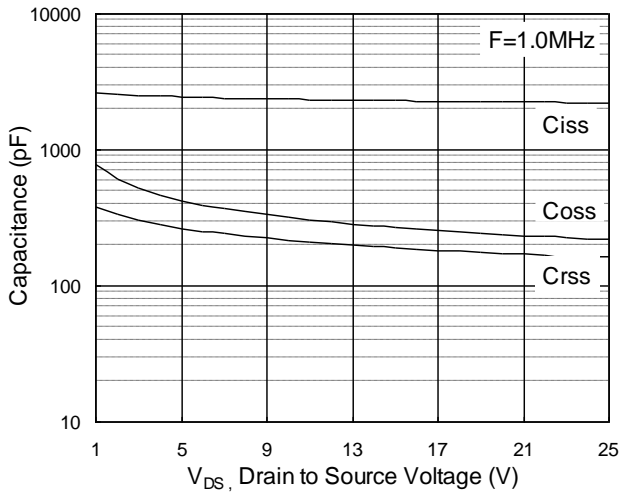

Fig.7 Capacitance

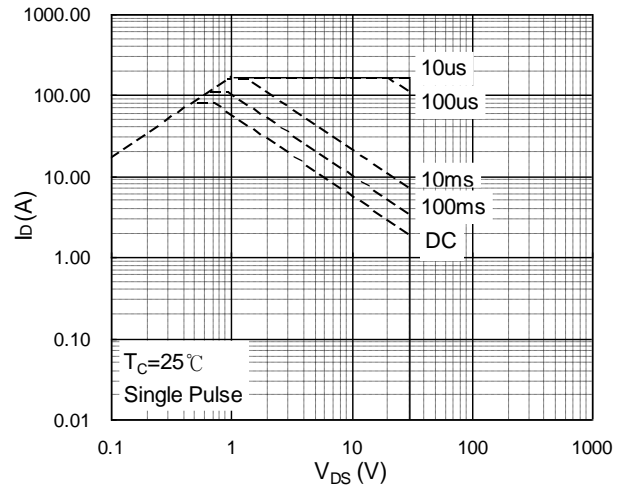

Fig.8 Safe Operating Area

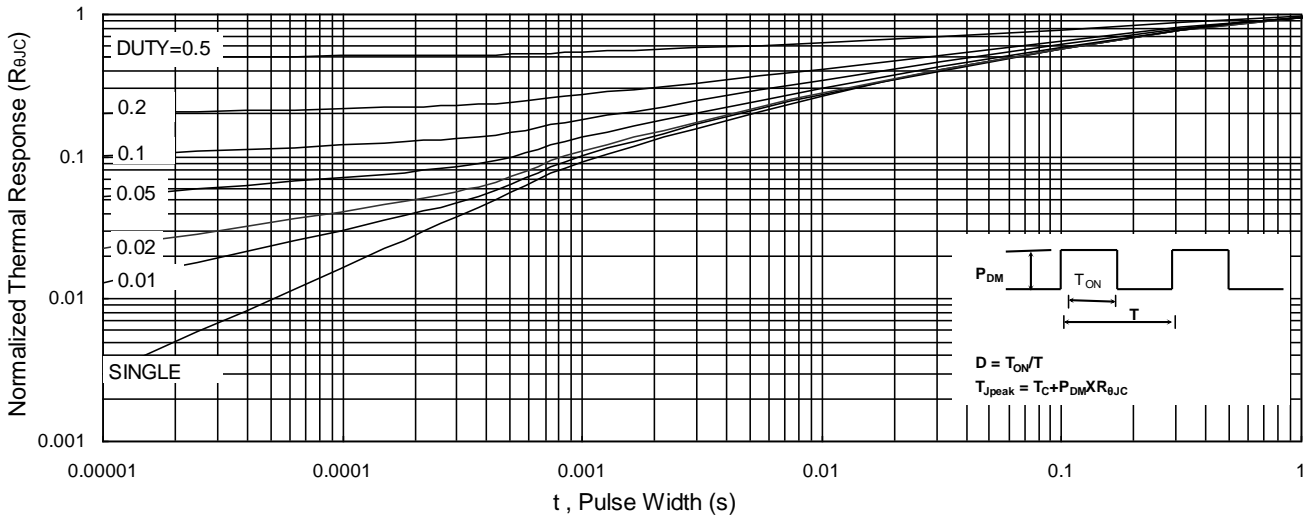

Fig.9 Normalized Maximum Transient Thermal Impedance



Fig.10 Switching Time Waveform

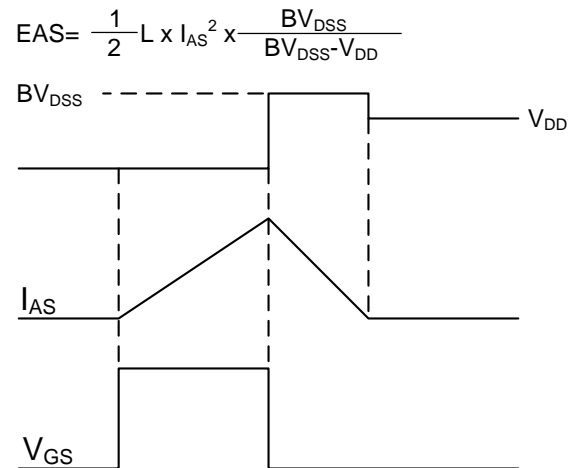

Fig.11 Unclamped Inductive Switching Waveform